

element™
DESIGN. QUALITY. PURPOSE

ELEMENT CA30X

ANDROID TERMINAL SERIES



www.elementpos.co

ELEMENT CA30X SERIES

CA309



CA308



CA307

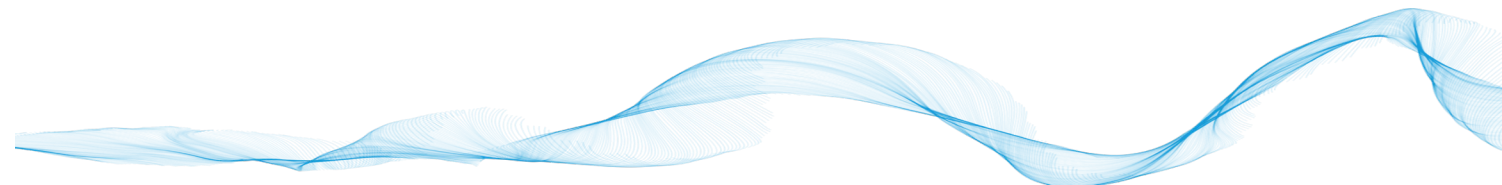

ELEMENT CA30X SERIES

11.6" & 15.6" Second display, mountable behind the stand

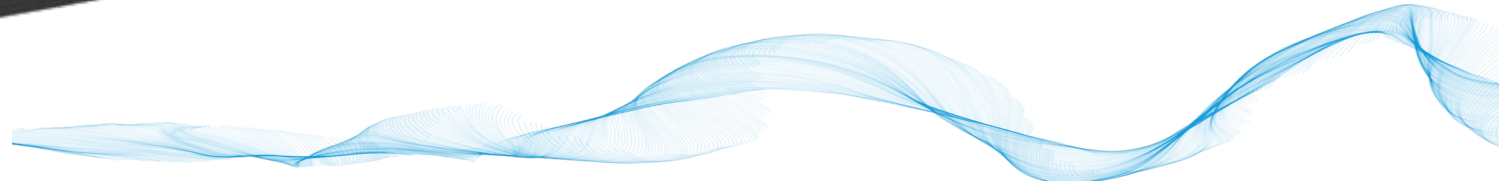

ELEMENT CA30X SERIES

Second Display Mounting Options



With bracket



On second display stand

ELEMENT CA30X SERIES

Second display bracket - supports 3 ways of mounting:

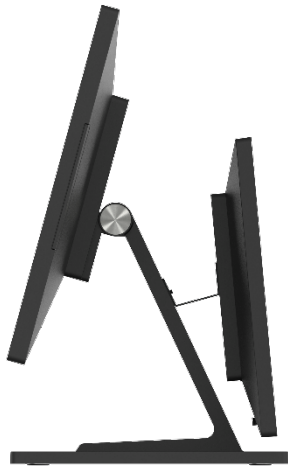

1
11.6" only



2
11.6" & 15.6"



3
11.6" only

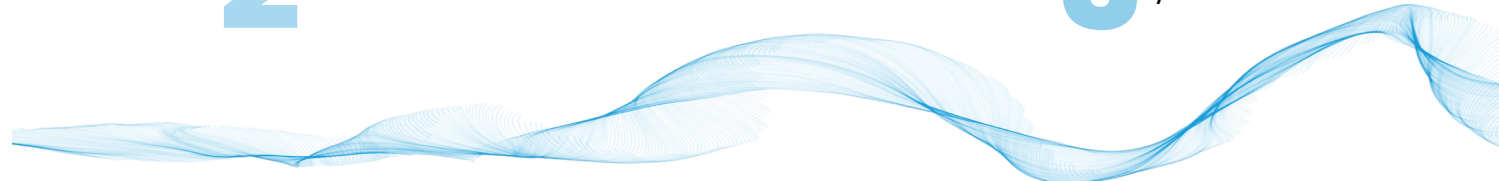

ELEMENT CA30X SERIES

NFC & camera option with CA307 11.6" Display



ELEMENT CA30X SERIES

Modular design

Two types of module,
adaptable to your needs:

1. Display Monitor Module

2. Touch PC Module



ELEMENT CA30X SERIES

Display Monitor Module I/O PORT

WITH SCALER BOARD
& PLASTIC HOUSING

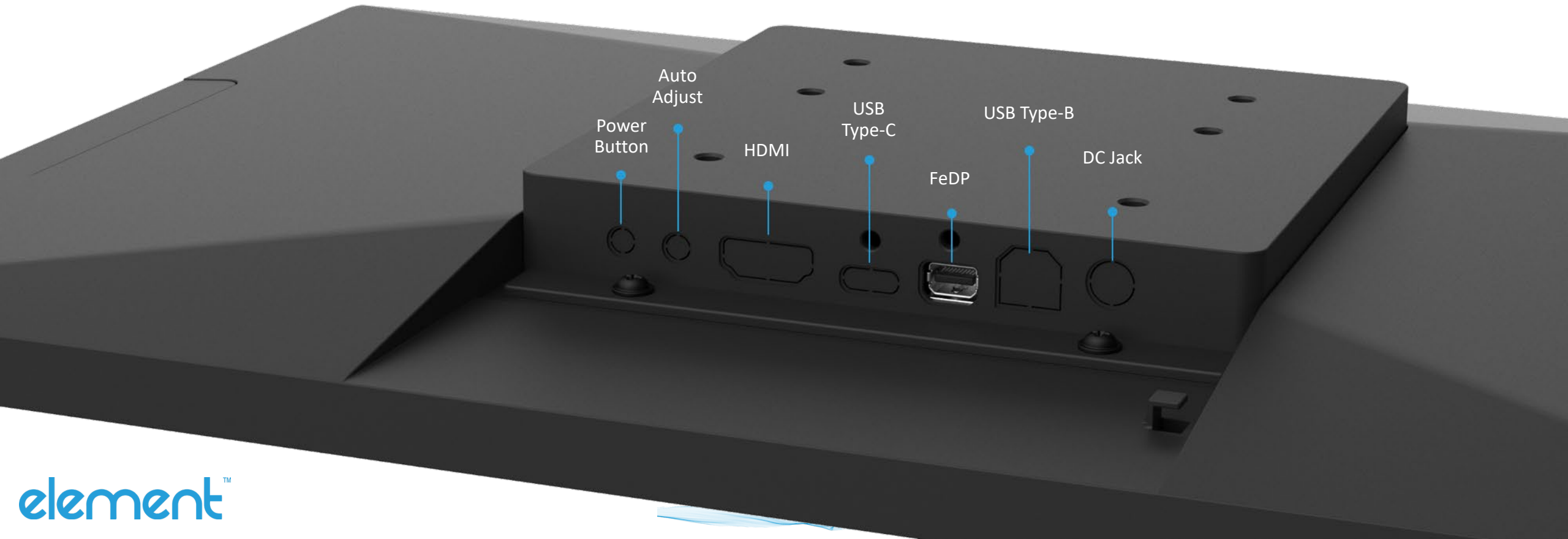

Auto
Adjust

Power
Button

HDMI

USB
Type-C

FeDP

USB Type-B

DC Jack

ELEMENT CA30X SERIES

CA307

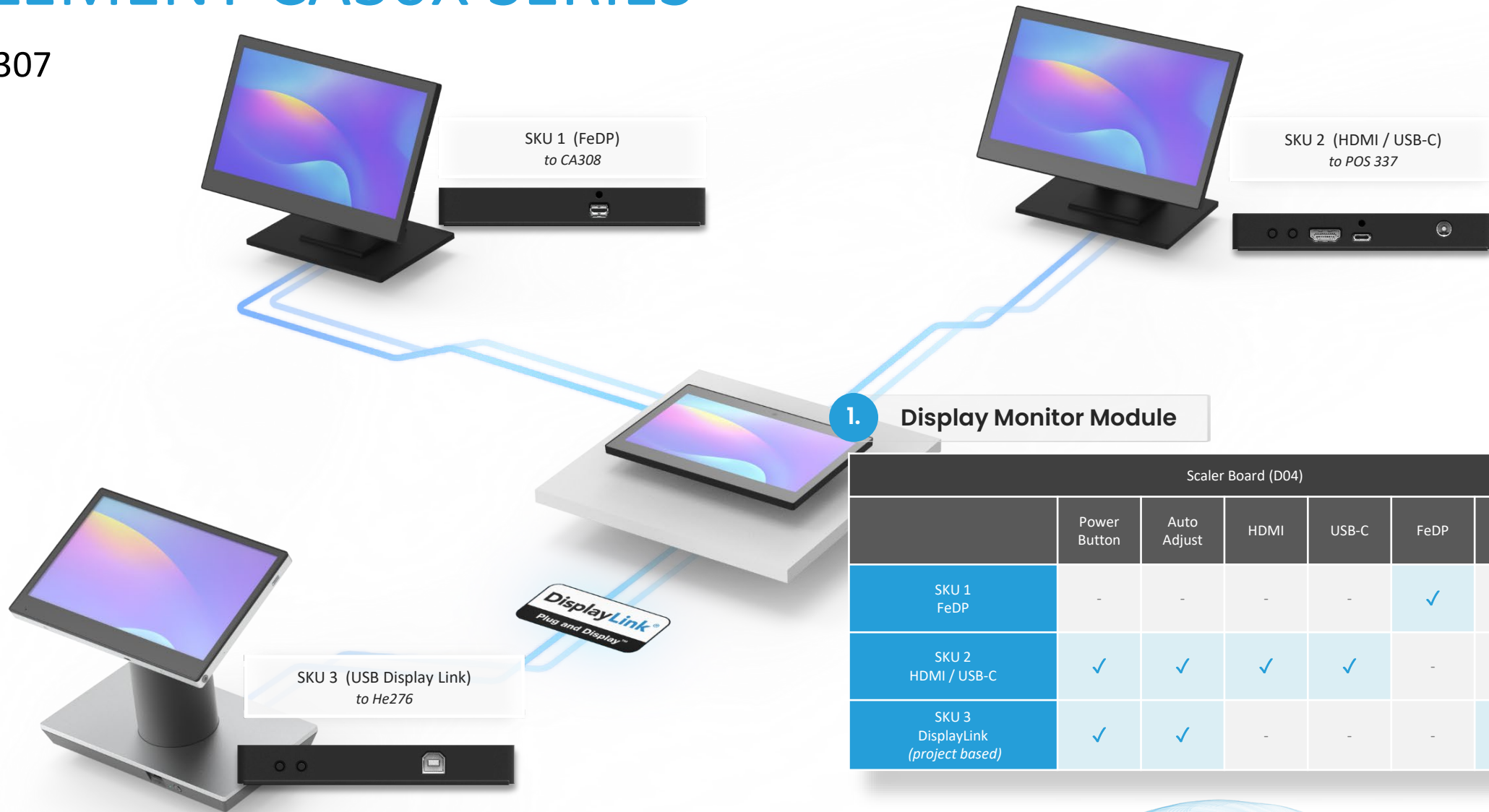

Scaler Board (D04)							
	Power Button	Auto Adjust	HDMI	USB-C	FeDP	USB -B	DC Jack
SKU 1 FeDP	-	-	-	-	✓	-	-
SKU 2 HDMI / USB-C	✓	✓	✓	✓	-	-	✓
SKU 3 DisplayLink (project based)	✓	✓	-	-	-	✓	-

ELEMENT CA30X SERIES

Touch Module I/O Port

WITH MOTHERBOARD & DIE CASTED HOUSING

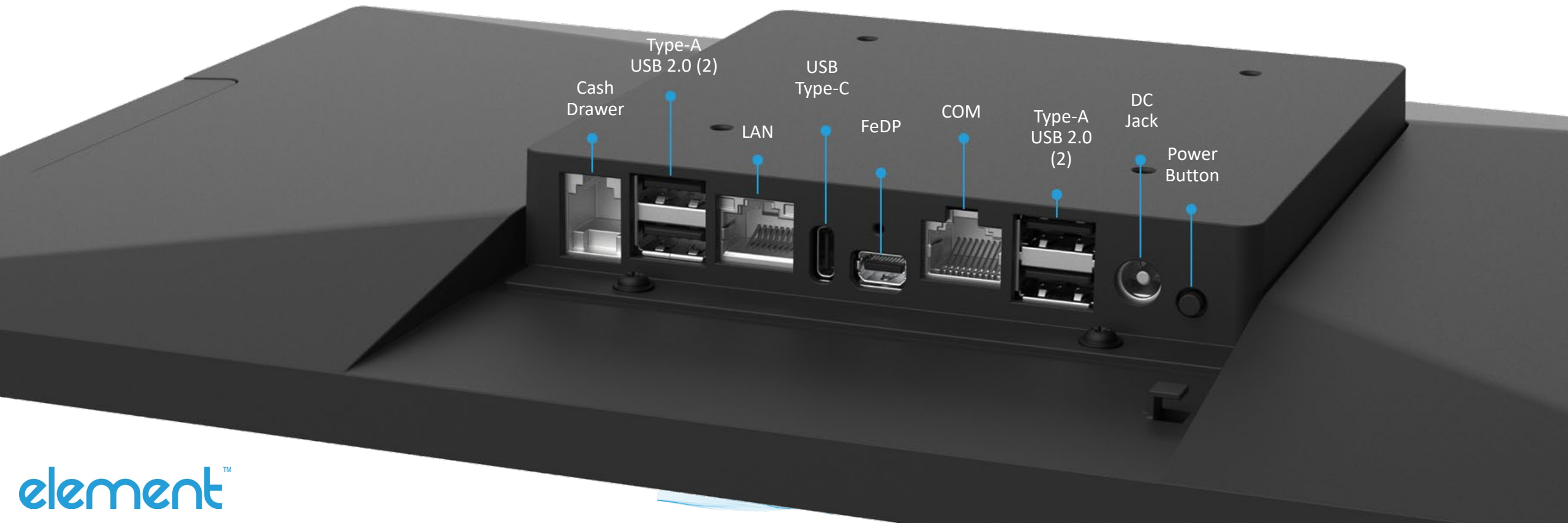

ELEMENT CA30X SERIES

Versatile solutions

Compatible with 75X75

VESA mount.

Kiosk



Wall Mounted



11"6
2nd Display Stand



POS Stand



Pole Mounted



ELEMENT CA30X SERIES

Peripheral Options

Compatible on one the right side.

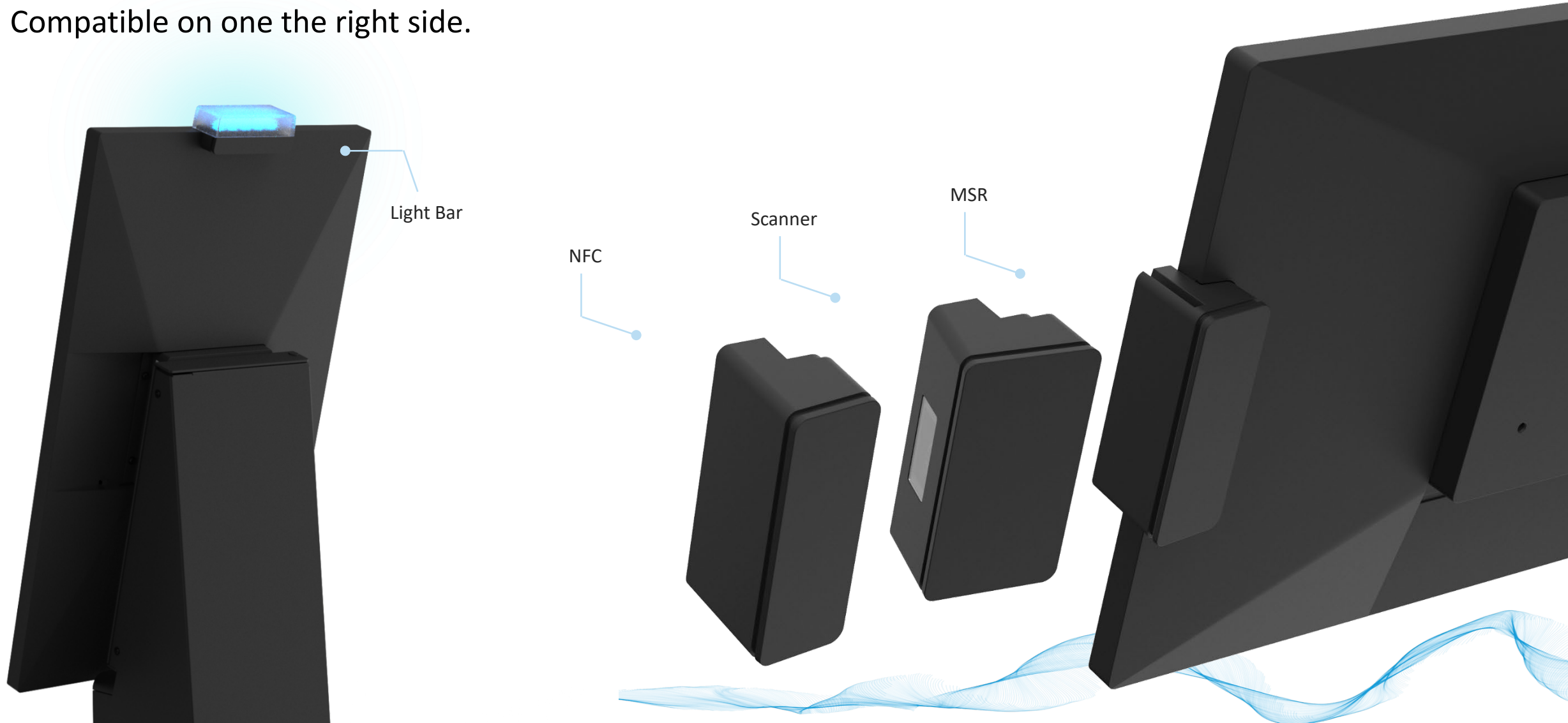

DIMENSIONS – CA307

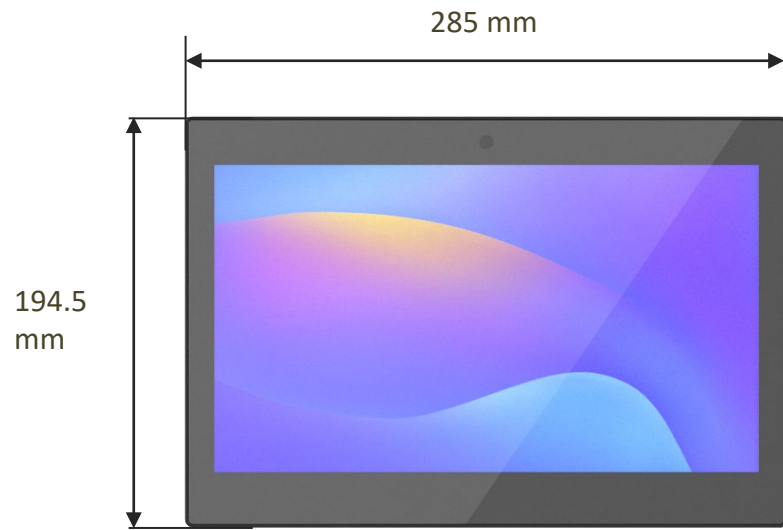

Mother Board

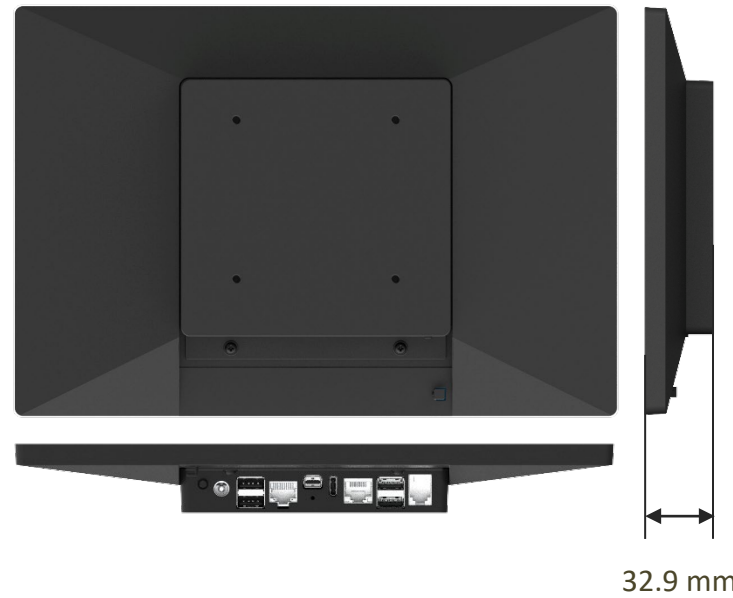

Scalar Board

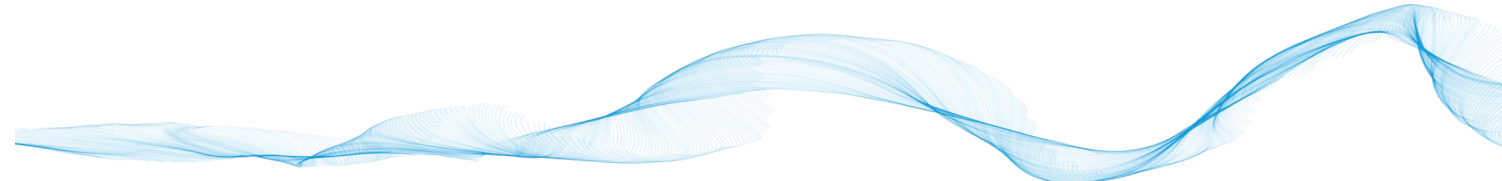

DIMENSIONS – CA308

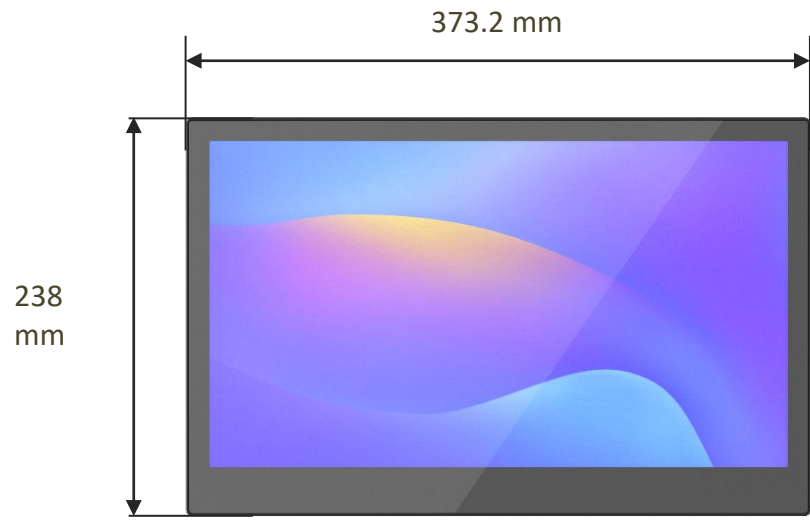

Mother Board



Scalar Board



33.2 mm

29.7mm

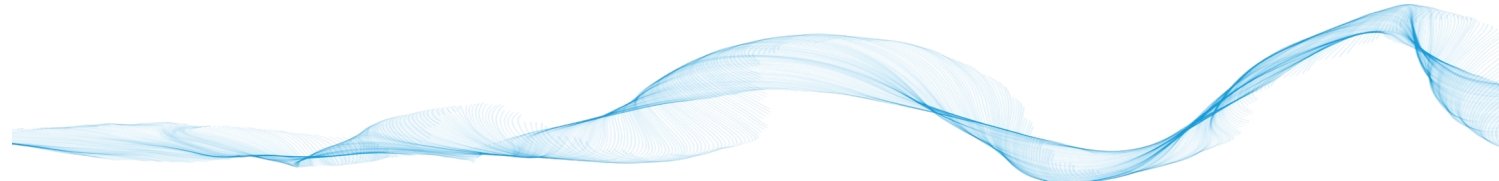

DIMENSIONS – CA309

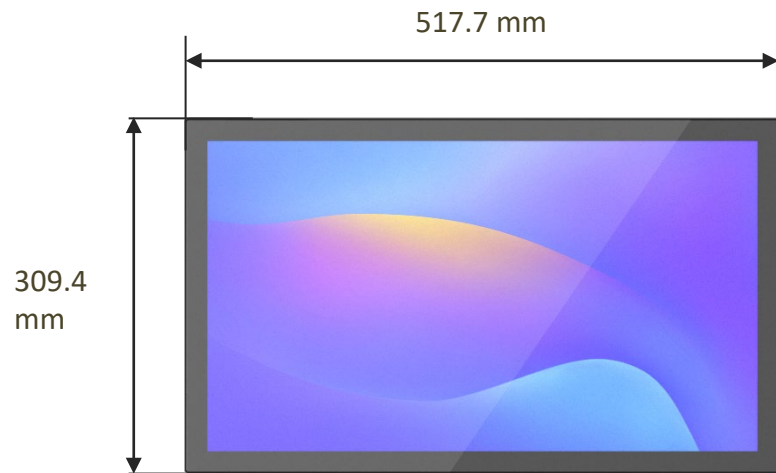

Mother Board

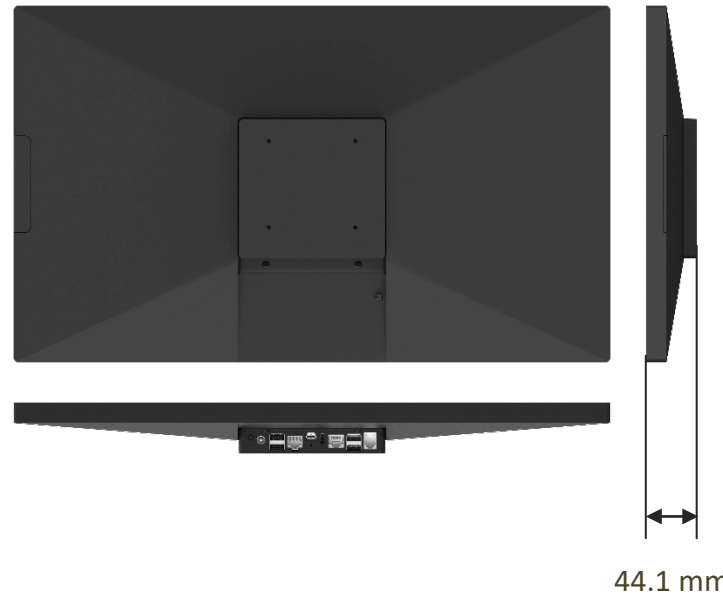

Scalar Board

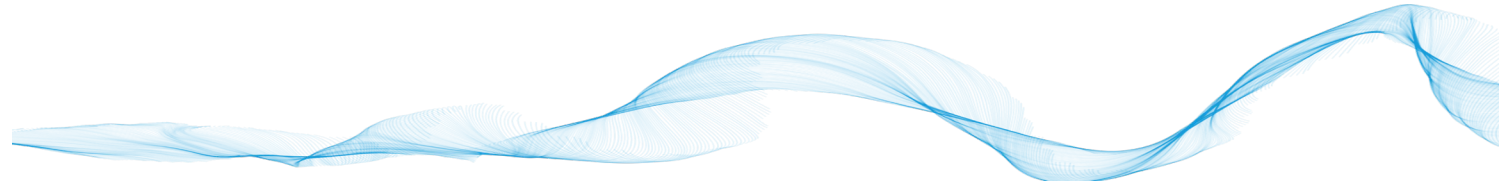
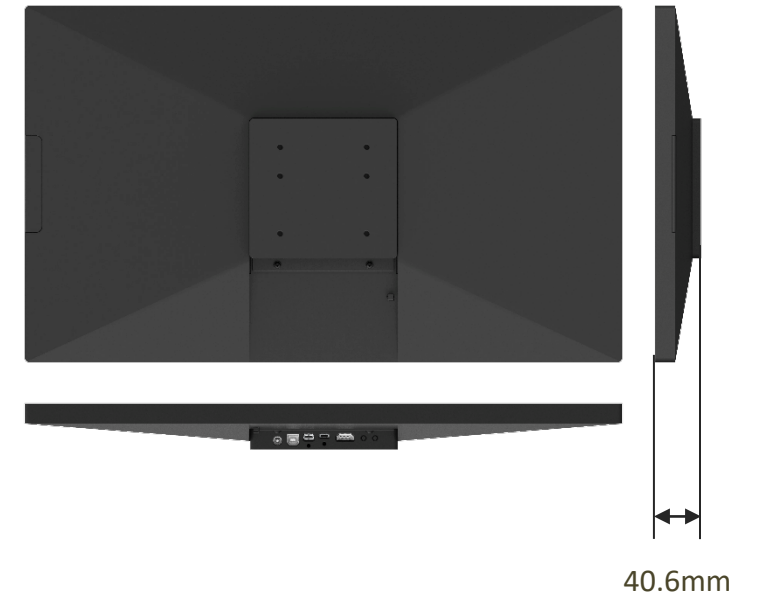

DIMENSIONS - STAND

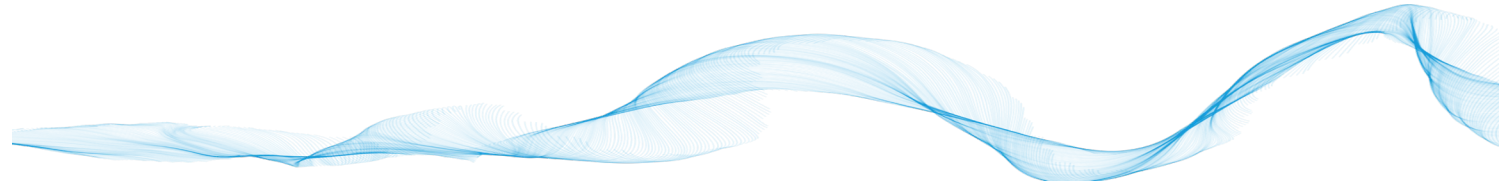
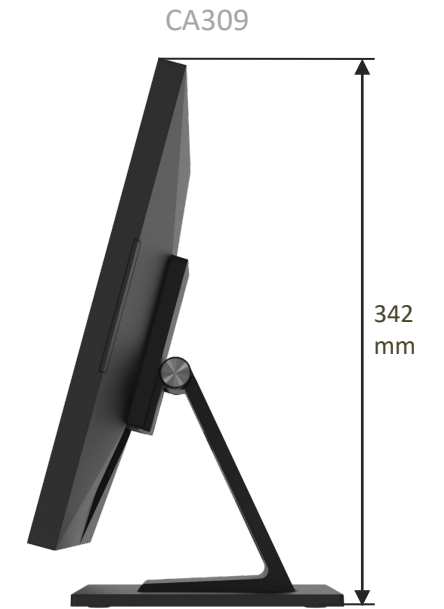
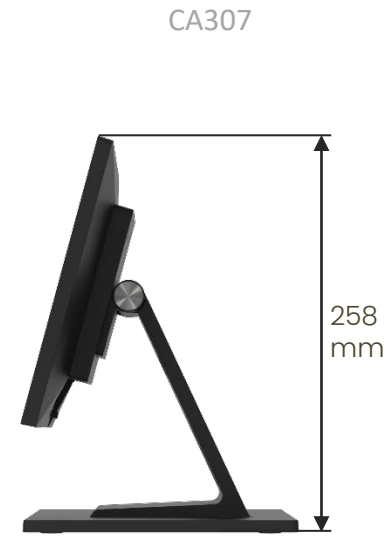
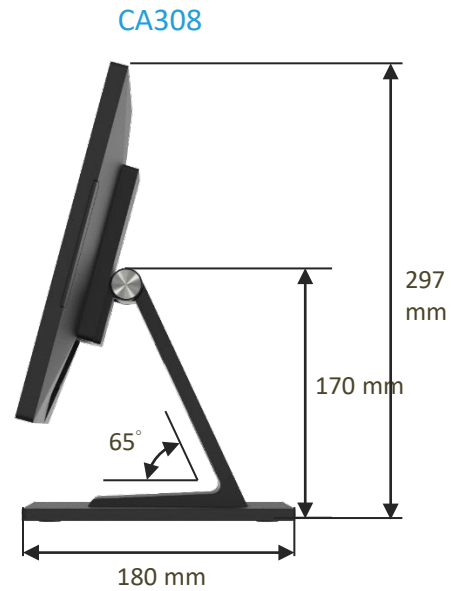
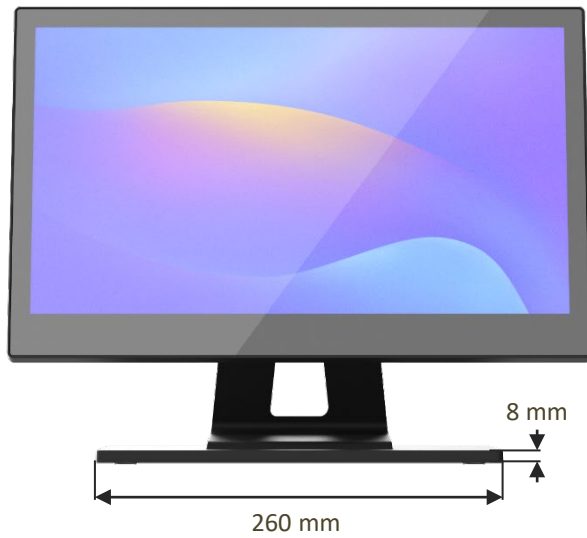

SPECIFICATIONS

Display Monitor Module – CA307				
Scaler Board (D04)		SKU1 (FeDP)	SKU2 (HDMI / USB-C)	SKU3 (USB DisplayLink)
I/O Ports	Power Button	-	1x	1x
	Auto Adjust Button	-	1x	1x
	HDMI	-	1x	-
	USB Type-C	-	1x USB2.0 support ALT with PD (5V/3A, 12V/1.25A)	-
	FeDP	1x Flytech proprietary miniDP	-	-
	USB Type-B	-	-	1x
	DC Jack	-	1x 2PIN	-
Certificate	EMC & Safety	FCC Class A, CE Mark Class A, LVD		
Environment	Operating Temperature	0°C ~ 35°C (32°F ~ 95°F)		
	Storage Temperature	-20°C ~ 60°C (-4°F ~ 140°F)		
	Humidity	20% ~ 85% RH non-condensing		

*Product specifications and data are subject to change without notice (E&OE)

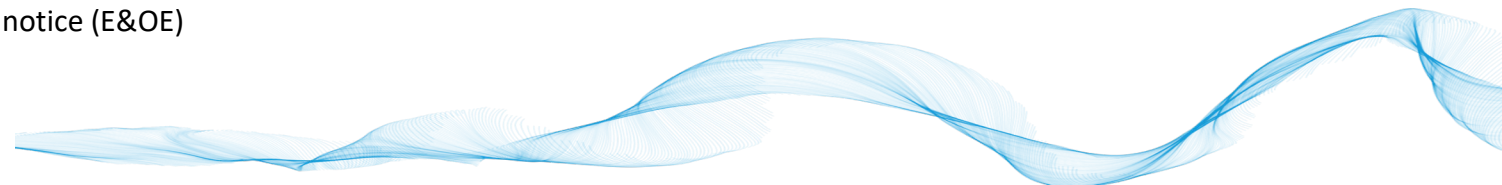

SPECIFICATIONS

Touch PC Module – CA307		
System	Motherboard	G17
	Processor	MTK G700 (MT8390)
	Memory	4GB DDR4
	Storage	64GB eMMC
I/O Ports	USB Type-A	4x USB2.0
	USB Type-C	1x USB3.0 (DP/ PD 5V/2A, 12V/1A)
	FeDP	1x Flytech proprietary miniDP (for 2nd display)
	Serial Port	1x RJ48 (Powered RS232) (default: 0V; support 5V, 12V)
	LAN	1x RJ45
	Cash Drawer	1x RJ11
	DC Jack	1x 2PIN
	Power button	1
	Certificate	EMC & Safety
Environment	Operating Temperature	0°C ~ 35°C (32°F ~ 95°F)
	Storage Temperature	-20°C ~ 60°C (-4°F ~ 140°F)
	Humidity	20% ~ 85% RH non-condensing

*Product specifications and data are subject to change without notice (E&OE)

SPECIFICATIONS

CA307		
System		
I/O Ports	(Display Monitor Module) / (Touch PC Module)	
Display	Size and Resolution	11.6" 1366x768
	Touch Screen	True-Flat PCAP multi-touch
Audio	Speaker	1x 3W (Option)
Power	Power Supply	36W / 12V
Mounting	VESA Mount	75 x 75
Communication	WLAN + BT	IEEE 802.11ax + BT5.2 (Option)
Peripheral (option)	MSR	3-Track MSR (USB)
	Fingerprint	Fingerprint Reader (USB)
	RFID	RFID Reader (USB)
	Scanner	2D Scanner (USB)
Camera	USB Camera	1x 2MP Fixed Focus
Certificate	EMC & Safety	FCC Class A, CE Mark Class A, LVD
Environment	Operating Temperature	0°C ~ 35°C (32°F ~ 95°F)
	Storage Temperature	-20°C ~ 60°C (-4°F ~ 140°F)
	Humidity	20% ~ 85% RH non-condensing
OS Supported	Android 13.0	
Dimensions	W x D x H	TBD
Weight	Weight	TBD

*Product specifications and data are subject to change without notice (E&OE)

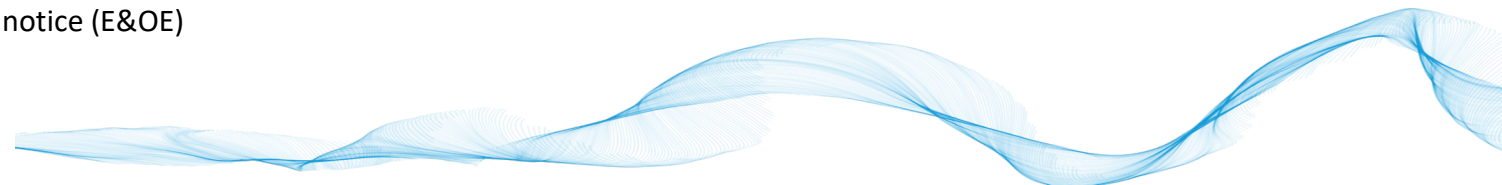

SPECIFICATIONS

CA308		
System		
I/O Ports	(Display Monitor Module) / (Touch PC Module)	
Display	Size and Resolution	15.6" 1920 x 1080
	Touch Screen	True-Flat PCAP multi-touch
Audio	Speaker	1x 3W (Option)
Power	Power Supply	36W / 12V
Mounting	VESA Mount	75 x 75
Communication	WLAN + BT	IEEE 802.11ax + BT5.2 (Option)
Peripheral (option)	MSR	3-Track MSR (USB)
	Fingerprint	Fingerprint Reader (USB)
	RFID	RFID Reader (USB)
	Scanner	2D Scanner (USB)
Certificate	EMC & Safety	FCC Class A, CE Mark Class A, LVD
Environment	Operating Temperature	0°C ~ 35°C (32°F ~ 95°F)
	Storage Temperature	-20°C ~ 60°C (-4°F ~ 140°F)
	Humidity	20% ~ 85% RH non-condensing
OS Supported	Android 13.0	
Dimensions	W x D x H	TBD
Weight	Weight	TBD

*Product specifications and data are subject to change without notice (E&OE)

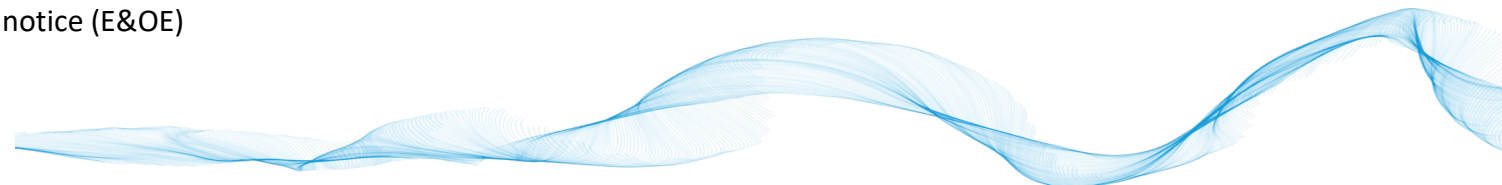

SPECIFICATIONS

CA309		
System	SLIDE	
I/O Ports		
Display	Size and Resolution	21.5" 1920 x 1080
	Touch Screen	True-Flat PCAP multi-touch
Audio	Speaker	1x 3W (Option)
Power	Power Supply	36W / 12V
Mounting	VESA Mount	75 x 75
Communication	WLAN + BT	IEEE 802.11ax + BT5.2 (Option)
Peripheral (option)	MSR	3-Track MSR (USB)
	Fingerprint	Fingerprint Reader (USB)
	RFID	RFID Reader (USB)
	Scanner	2D Scanner (USB)
Certificate	EMC & Safety	FCC Class A, CE Mark Class A, LVD
Environment	Operating Temperature	0°C ~ 35°C (32°F ~ 95°F)
	Storage Temperature	-20°C ~ 60°C (-4°F ~ 140°F)
	Humidity	20% ~ 85% RH non-condensing
OS Supported	Android 13.0	
Dimensions	W x D x H	TBD
Weight	Weight	TBD

*Product specifications and data are subject to change without notice (E&OE)

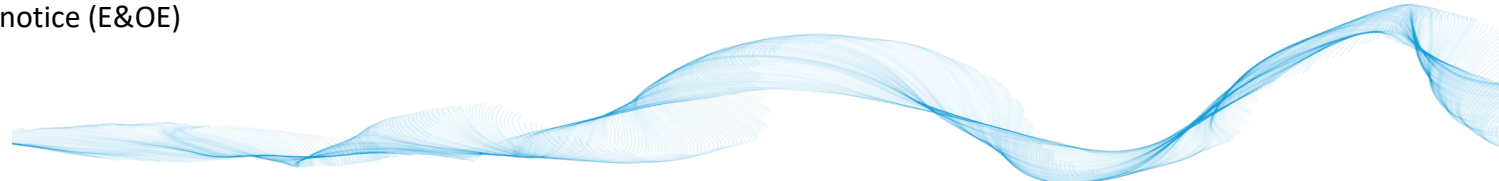

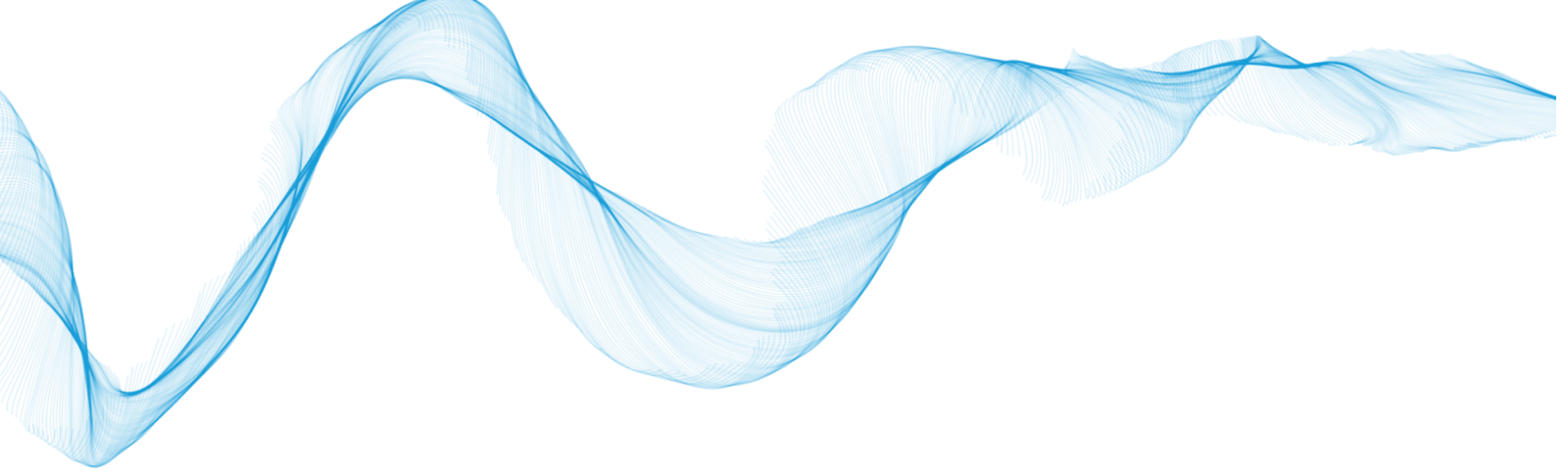

element™

www.elementpos.co